

# BIOHF

BIO - 1000/1200 W TUNGSTEN



- **Type:** Single lens luminaire
- **Source:** 1000/1200 W Tungsten
- **Optics:** 200 mm Fresnel lens

Single lens

## Reliable and easy to maintain

A large 200 mm lens gives unparalleled light output and quality of beam. The 310H is at home in every venue, large and small, and offers broad coverage with a smooth, even beam. Designed for easy maintenance, this unit has a well-earned reputation for reliability.

### Features

- **Theatre front cassette:** no light spill to distract audiences or performers
- **Colour runners:** double runners to hold accessories and colour filters
- **Barn door:** unique rotating barn door with 4 individually rotating blades – makes even the most difficult angle possible
- **Focus adjustment:** smooth focus adjustment from rear, even when lantern is hot, for a longer lamp life
- **Tilt reference on hanging yoke:** index for rapid re-positioning

### Optical

- **Multiposition socket:** accepts 1000 W and 1200 W lamps
- **Unique 200 mm (8 in) lens:** no equivalent on the market in terms of light output and beam quality

### Construction

- **Made in France :** fully manufactured in Robert Juliat premises retaining complete control over all aspects of quality
- **Air vents:** efficient cooling with no light spill
- **Bodywork:** strong sheet metal construction for durability
- **Moving parts:** smooth at all times, even when hot
- **Captive knobs and handles:** additional security when working at height or in transit
- **Access:** easy access to lamp house and lenses through front opening for fast and efficient maintenance
- **Easy access to all parts:** easy cleaning, re-lamping and maintenance
- **Safety grid:** earthed safety grid fitted as standard
- **Safety first:** front accessories safety cable attachment point

Picture:310H

DSEN005\_310HF - 23/03/2022

Robert Juliat reserves the right to change or alter any of the items detailed on this page, to increase or improve manufacturing techniques without prior notice.

Robert Juliat S.A.S., 32 rue de Beaumont, 60530 Fresnoy-en-Thelle - France  
Telephone : +33 (0)3 44 26 51 89 - fax : +33 (0)3 44 26 90 79 - info@robertjuliat.fr  
www.robertjuliat.com



ROBERT JULIAT

## Source

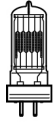

- **Lamp type:** Tungsten
- **Socket:** Gx9.5

| Admissible lamps               | Power * | Lumen output* | Colour temperature* | Life* |
|--------------------------------|---------|---------------|---------------------|-------|
| LIF: T19 (T11) - ANSI: FWP/FWR | 1 000 W | 21 000 lm     | 3050K               | 750 h |
| LIF: CP70 - ANSI: FVA/FVB      | 1 000 W | 26 000 lm     | 3200K               | 200 h |
| LIF: T29 - ANSI: FWS/FWT       | 1 200 W | 29 000 lm     | 3050K               | 400 h |
| LIF: CP90                      | 1 200 W | 30 000 lm     | 3200K               | 200 h |

(\*) manufacturer's data

## Optics

### Characteristics

- **Type:** Single lens
- **Beam range:** 6° to 46°
- **Lens:** 200 mm Fresnel lens

### Gel filter

- **Shape:** Square
- **Standard size:** 215x215 mm (8.5x8.5 in)

## Photometrics

with LIF: CP90 source

### • Optics @ 6°

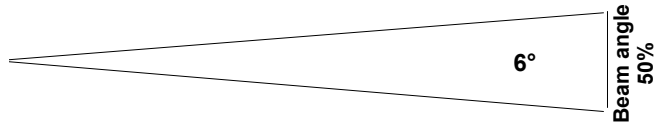
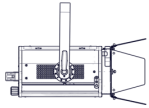

**Beam intensity**  
220 000 cd

|                     |            |           |           |           |           |         |
|---------------------|------------|-----------|-----------|-----------|-----------|---------|
| <b>Distance</b>     | 3 m        | 5 m       | 7 m       | 10 m      | 12 m      | 15 m    |
| <b>Diameter</b>     | 0.3 m      | 0.5 m     | 0.7 m     | 1 m       | 1.3 m     | 1.6 m   |
| <b>Illumination</b> | 24 500 lux | 8 900 lux | 4 500 lux | 2 250 lux | 1 550 lux | 980 lux |
| <b>Distance</b>     | 10 ft      | 15 ft     | 25 ft     | 35 ft     | 40 ft     | 50 ft   |
| <b>Diameter</b>     | 1 ft       | 1.6 ft    | 2.6 ft    | 3.7 ft    | 4.2 ft    | 5.2 ft  |
| <b>Illumination</b> | 2 250 fc   | 980 fc    | 360 fc    | 180 fc    | 140 fc    | 90 fc   |

### • Optics @ 46°

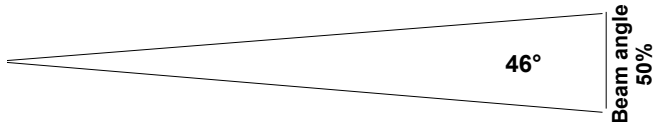
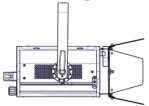

**Beam intensity**  
25 000 cd

|                     |           |           |         |         |         |         |
|---------------------|-----------|-----------|---------|---------|---------|---------|
| <b>Distance</b>     | 3 m       | 5 m       | 7 m     | 10 m    | 12 m    | 15 m    |
| <b>Diameter</b>     | 2.5 m     | 4.2 m     | 5.9 m   | 8.5 m   | 10.2 m  | 12.7 m  |
| <b>Illumination</b> | 2 800 lux | 1 010 lux | 520 lux | 260 lux | 180 lux | 120 lux |
| <b>Distance</b>     | 10 ft     | 15 ft     | 25 ft   | 35 ft   | 40 ft   | 50 ft   |
| <b>Diameter</b>     | 8.5 ft    | 12.7 ft   | 21.2 ft | 29.7 ft | 34 ft   | 42.4 ft |
| <b>Illumination</b> | 260 fc    | 120 fc    | 41 fc   | 21 fc   | 16 fc   | 11 fc   |

## Dimensions and weight

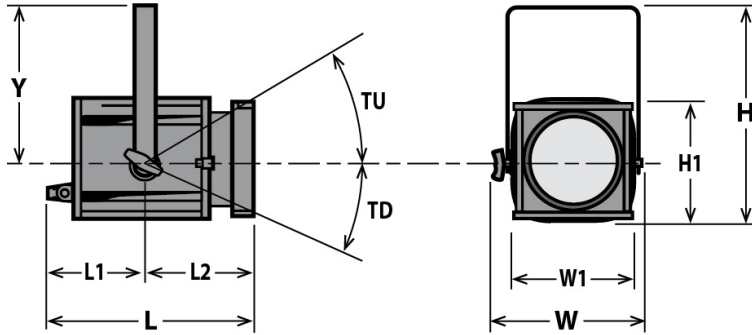

**Weight:** 7.7 kg (16.9 lbs)

| Height                                     | Length   | Width                                      | Yoke                | Tilt                |
|--|--|--|---------------------|---------------------|
| H= 440 mm (17.3 in)<br>H1= 250 mm (9.8 in) | L= 465 mm (18.3 in)<br>L1= 260 mm (10.2 in)<br>L2= 205 mm (8.1 in) | W= 350 mm (13.8 in)<br>W1= 250 mm (9.8 in) | Y= 315 mm (12.4 in) | TU= TBD°<br>TD= 90° |

## Shipping

- **Weight :** 9.2 kg (20.2 lbs)
- **Volume :** .06 m<sup>3</sup> (2.26 ft<sup>3</sup>)

## Installation

- **Minimum distance to illuminated surface:** 1.1 m ( 3.6 ft )
- **Operating position:**



## Warranty

- **Fixture: 2 years**  
See General Sales Condition on website

## Approvals



## Construction

- **Housing:** Steel sheet - Aluminium
- **Colour:** Black
- **Cooling:** Convection cooling
- **Maximum ambient temperature (Ta):** 40°C (104°F)
- **Maximum case temperature (Tc):** 200°C (392°F)
- **Total heat dissipation:** 3 413 BTU/h
- **Ingress Protection (IP) rating:** IP20

## Electrical compatibility

- 230/240 V - 50 Hz
- ~~115/120 V - 60 Hz~~

## Power input



- **Type:** attached power cord
- **Cable:** H07RNF 3G1.5
- **Length:** 3 m (9.8 ft)
- **Power connector:** CEE 7/7 (2P+E NF/Schuko)

## Power consumption

| Voltage | Frequency | Current | Power  |
|---------|-----------|---------|--------|
| 230 V   | 50 Hz     | 5 A     | 1000 W |
| 230 V   | 50 Hz     | 6 A     | 1200 W |











## Model

|              |   |
|--------------|---|
| <b>310HF</b> | 1000/1200 W Tungsten Single lens luminaire - Gx9.5 socket - 200mm Fresnel - 310HF |
|--------------|---|

## Options

|                 |   |   |
|-----------------|---|---|
| <b>PCP1716A</b> | 16A blue 2P+E 6h IEC60309 power connector |  |
|-----------------|---|---|

## Accessories

|                  |   |   |
|------------------|---|---|
| <b>PF1000M2</b>  | 215x215mm metal filter holder<br><b>1 included</b>  |    |
| <b>G1000</b>     | 215x215mm safety grid<br><b>1 included</b>  |    |
| <b>CP70</b>      | CP70 - Gx9.5 1000W 230V 200h 3200K lamp   |    |
| <b>T19 (T11)</b> | T19 (T11) - Gx9.5 1000W 230V 750h 3050K lamp  |    |
| <b>CP90</b>      | CP90 - Gx9.5 1200W 230V 200h 3200K lamp   |   |
| <b>CF1000</b>    | 4 rotating leaves on a rotating barndoor - 215x215mm ( without safety cable) - Poids: 1.03 Kg |  |
| <b>876</b>       | Hook clamp 40x10mm with 28mm M10 screw for Ø35 to 50mm pipes - SWL: 50Kg - Poids: 1.25 Kg     |  |
| <b>880</b>       | Hook clamp 40x10mm with 28mm M10 screw for Ø50 to 63mm pipes - SWL: 50Kg - Poids: 1.36 Kg     |  |
| <b>CS2</b>       | Safety cable Ø3 mm L= 600mm - SWL: 75 Kg  |  |
| <b>CS5</b>       | Safety cable Ø1,5 mm L=300mm for front accessory with karabiner and quick link - SWL: 25 Kg   |  |